

OPTIMA STEAMER

Accessories Catalog



[A70015] Steam Gun K26 with nozzle 3.5



Ø3.5 Steam Nozzle
with Silicone protector

Matching Accessories



[A70030] Steam hose PTFE 6-8, 10m

[A70057] Steam hose PTFE 6-8, 15m

[A70058] Steam hose PTFE 6-8, 20m

※ Max. 300cc/min dry steam (with Ø3.5 steam nozzle)

[A70019] Steam Gun RL22 with nozzle 5.5, power



Ø5.5 Steam Nozzle
with Silicone protector

Matching Accessories



[A70039] Power hose PTFE 8-10, 10m

[A70059] Power hose PTFE 8-10, 15m

[A70060] Power hose PTFE 8-10, 20m

※ Max. 850cc/min dry steam (with Ø5.5 steam nozzle)

▶ Using the RL22 Steam gun & Power steam hose sprays much more amount of dry steam than using the K26 Steam gun & Standard steam hose.

Steam Temperature from Gun Nozzle

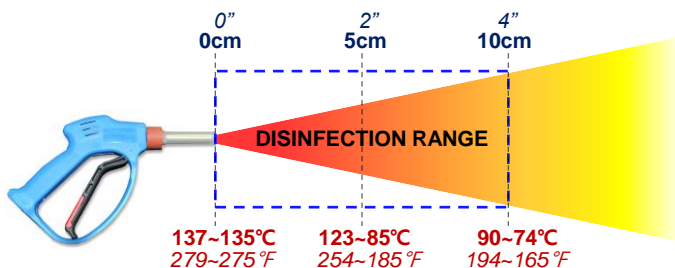

Lance Steam Gun K26 with nozzle 3.5

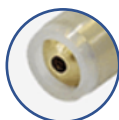

Ø3.5 Steam Nozzle
with Silicone protector

[A70010] Steam Gun K26 (L.300mm)



[A70011] Steam Gun K26 (L.500mm)



[A70012] Steam Gun K26 (L.600mm)



[A70013] Steam Gun K26 (L.1,000mm)



Lance Steam Gun RL22 with nozzle 5.5



Ø5.5 Steam Nozzle
with Silicone protector

[85-50084] Steam Gun RL22 (L.300mm)



[85-50085] Steam Gun RL22 (L.500mm)



[85-50086] Steam Gun RL22 (L.600mm)



[85-50087] Steam Gun RL22 (L.1,000mm)



OPTIMA STEAMER



Quick Connectors for Accessories

For Light Attachments

[71207]
SCP30 Quick Plug

[71205]
SC20 Quick Coupler

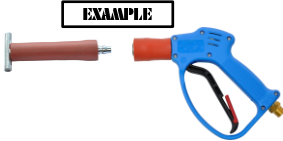

For Heavy Attachments

[35-50040]
KPS45 Quick Plug

[35-50041]
KC35 Quick Coupler



Quick Connector Instructions

HOW TO CONNECT

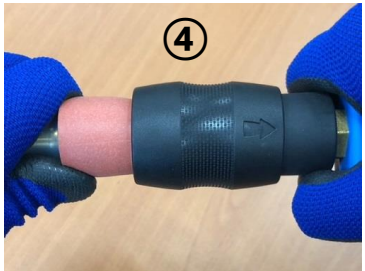
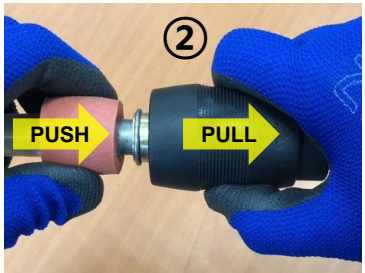
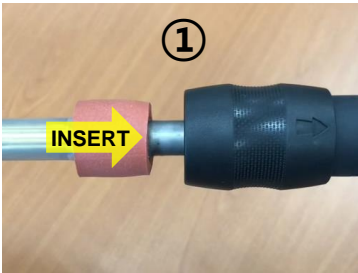

HOW TO DISCONNECT

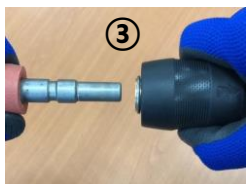
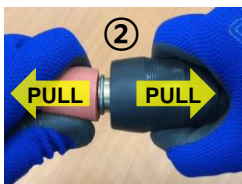

[A70274] Steam Gun K26 with SC20 Quick Coupler



SCP30
Quick Plug

SC20
Quick Coupler



Matching Accessories

[A70026] Steam nozzle

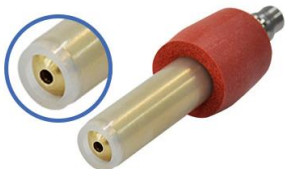

※ Ø3.5 Steam Nozzle
with silicone protector

[A71607] Silent steam nozzle

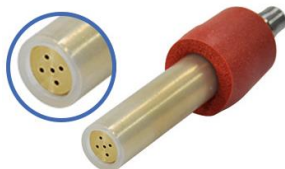

※ Reduces the pressure of the steam
spray as well as the noise levels.

Flat Steam Nozzles with SCP30 Quick Plug

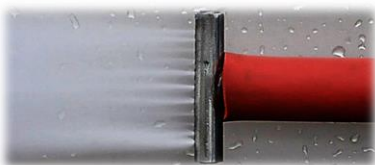

※ Flat nozzles are Suitable for HVAC cleaning

[A70247] Flat nozzle 50



[A70025] Flat Fan nozzle 50



[85-50212] Flat nozzle 100

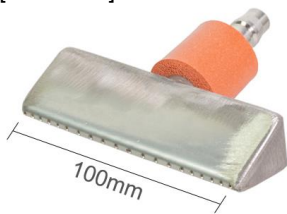

[A71608] Turbo Steam Nozzle with SCP30 Quick Plug



※ Cleaning and Sanitizing fabrics,
mats, mesh screens, etc.



Steam Guns with KC35 Quick Coupler (Highly Recommended)

[85-50047]

Steam Gun K26 with KC35



※ Example of usage



[85-50130]

Steam Gun RL22 with KC35



KPS45
Quick Plug



INSERT

KC35
Quick Coupler



Matching Accessories

[85-50145] Steam Nozzle Ø3.5



[85-50137] Steam Nozzle Ø5.5

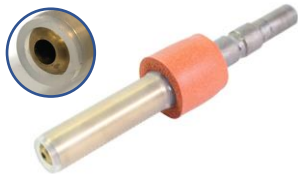

Steam Lances with Ø3.5 nozzle (KPS45 Quick Plug Applied)

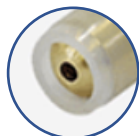

※ Ø3.5 Steam Nozzle
with silicone protector

[85-50149] L.400mm (straight)



[85-50148] L.700mm (straight)



[85-50147] L.1,000mm (straight)



[85-50146] L.1,200mm (straight)



Steam Lances with Ø5.5 nozzle (KPS45 Quick Plug Applied)



※ Ø5.5 Steam Nozzle
with silicone protector

[85-50149] L.400mm (straight)



[85-50148] L.700mm (straight)



[85-50147] L.1,000mm (straight)



[85-50146] L.1,200mm (straight)



Matching Accessories

[85-50057] Spray bottle 350ml



※ The Spray Bottle allows you to mix detergent or wax into your steam.

[85-53008] Floor Brush



[85-50056] Floor Spinner with KPS45 Quick Plug



Matching Accessory

[85-50088]
Heat-resistant
Vacuum hose

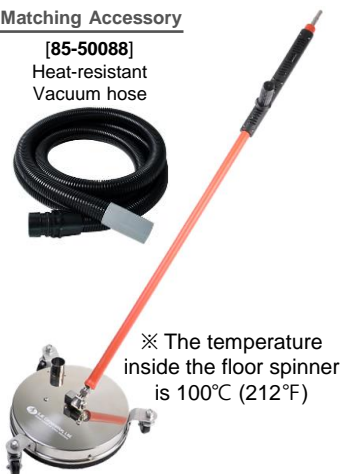

[85-50187] Sand Sanitizing Wand with KPS45 Quick Plug



※ Sand Sterilization at beach, playground, etc.

Brush Holder Attachments (Slide-On Accessories)



[71393]
Steel Brush



[71392]
Polyester Brush



[71391]
Polyester Brush



[70284]
Nylon Brush



[71394]
Plastic Scraper



[70302]
Metal Scraper



Straight Lances with Brush Holder (KPS45 Quick Plug Applied)



[85-50149] L.400mm (straight)



[85-50148] L.700mm (straight)



[85-50147] L.1,000mm (straight)



[85-50146] L.1,200mm (straight)



Bent Lances with Brush Holder (KPS45 Quick Plug Applied)



[85-50076] L.100mm (45°)



[85-50077] L.250mm (45°)



[85-50078] L.400mm (45°)



[85-50064] L.700mm (45°)



[85-50063] L.1,000mm (45°)



Weed Control Accessories (Weed Removal Tools)



※ Eradicate weeds using nothing but steam. The Weed Control Accessories inject steam into the root of weeds, delivering a concentrated dose of high temp moisture that begins killing plants immediately, all without the use of toxic herbicides. In a matter of days, the targeted plants will wilt and die, killed from the roots so the plant won't continue to regrow.



[A70014] Steam Gun K26 with Weeding nozzle



[85-50138] Weed Control, Bell with KPS45 Quick Plug



[85-50035] Weed Control, Brush with KPS45 Quick Plug



[71393]
Steel Brush
included

[85-50036] Weed Control, Spear with KPS45 Quick Plug

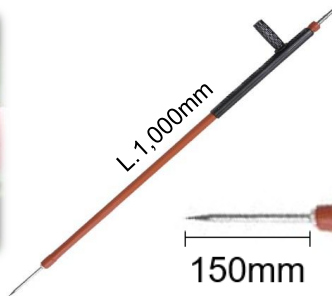

[85-50037] Weed Control, Flat with KPS45 Quick Plug



[85-50038] Weed Control, Roller with KPS45 Quick Plug



Mop Wands with Squeegee (Telescoping Pole Applied)

[85-50089] Mop wand with squeegee (0.8 ~ 1.2 meter)

[85-50091] Mop wand with squeegee (1.4 ~ 2.4 meter)

[85-50092] Mop wand with squeegee (1.5 ~ 3.6 meter)

[85-50093] Mop wand with squeegee (2.2 ~ 5.5 meter)

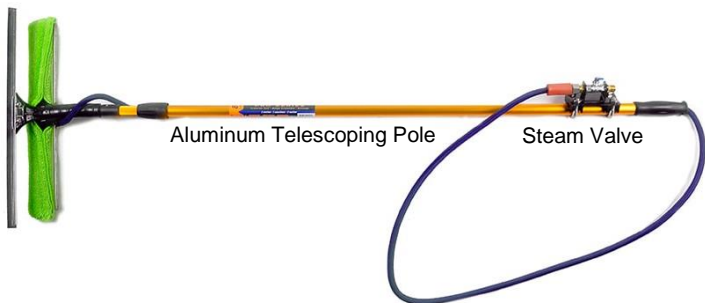

Spare Parts

[25-50025] Spare Mop 45cm

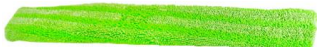

[71192] Spare Rubber 45cm



[85-50179] Steam Extractor Hand Tool



Required Accessory

[85-50088]

Heat-resistant
Vacuum hose



※ Cleaning and Sanitizing carpets & mats
in combination with a vacuum cleaner



[85-50135] Barrel Cleaning Tool with bimetal thermometer



※ Using the Optima Steamer and our Barrel Cleaning Tool will use a fraction of the water you would use with a pressure washer, kill more bacteria in the surface of the barrel and penetrate deeper, will produce swell in minutes — not hours — and will preserve toasting flavors and character rather than flushing them away.

Conveyor Belt Cleaning Tools, Pneumatic type



Part Number	85-50201	85-50180	85-50200
Required Steamer	OPTIMA XE 27K, SEII 27K/42K		
Required Steam Pressure	5~7 bar		
Required Compressed Air	Air Compressor, 14.4 CFM @8 bar		
Working Pressure	73~116 psi (5~8 bar)		
Working Speed	150~1,000 mm/s (5.9~39.4 inch/s)		
Recommended Belt	non-flat open surface type (plastic modular, metal wire, rollers)		
Material	Aluminium, Stainless		
A Air Inlet	Standard air quick plug		
B Cleaning Width, Max.	610mm / 24"	1,000mm / 39"	1,220mm / 48"
B Cleaning Width, Min.	100mm / 4"		
C Mounting Width, Max.	970mm / 38.1"	1,360mm / 53.5"	1,580mm / 62.2"
C Mounting Width, Min.	300mm / 11.8"		
Dimension(L X W X H) mm	1320 X 160 X 730	1710 X 160 X 730	1930 X 160 X 730
Dimension(L X W X H) inch	51.97 X 6.3 X 28.75	67.33 X 6.3 X 28.75	75.99 X 6.3 X 28.75
Weight, kg (lbs)	12 (26.5)	13.2 (29.1)	14.5 (32)

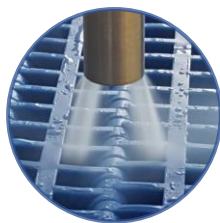
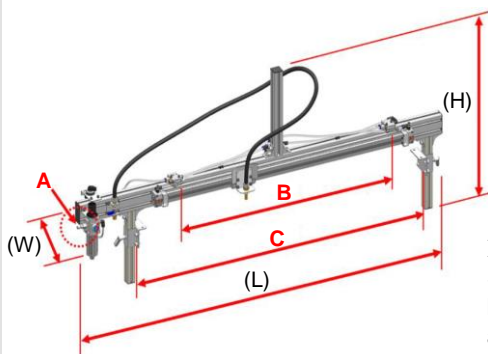

※ Steam Cleaning and Sanitizing the conveyor belts in combination with an air compressor.



BEFORE



AFTER

[85-50082] Conveyor Belt Cleaning Tool, Basic

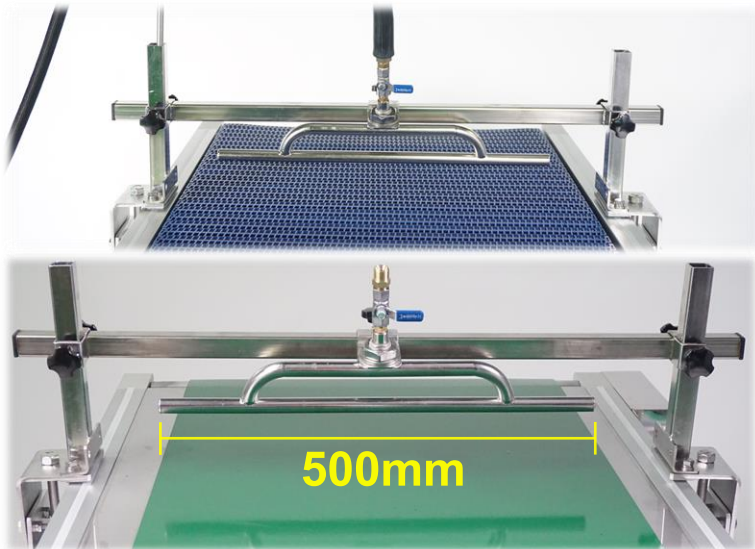

Similar Item

[85-50132] Conveyor Tool, Basic (Mounting Width 1,000mm)

[85-50083] Conveyor Belt Cleaning Tool, Suction type

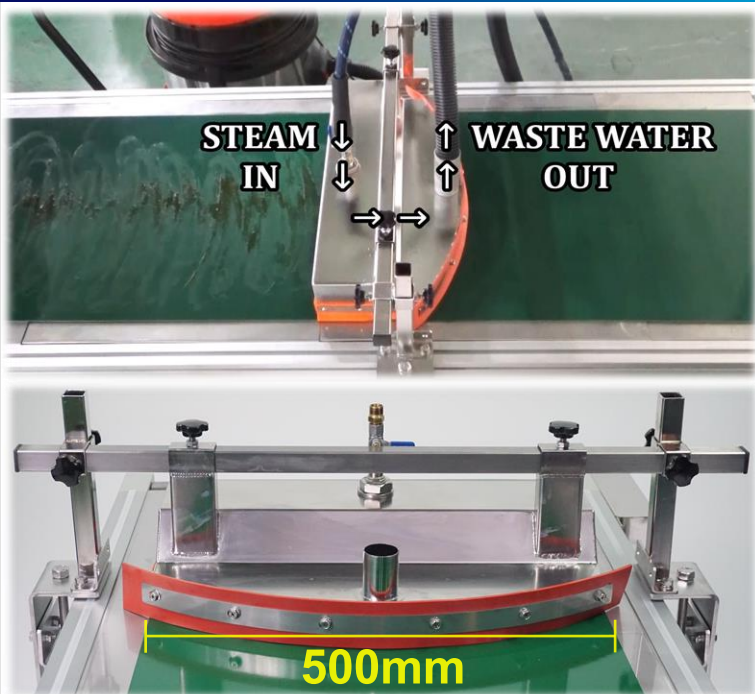

Similar Item

[85-50131] Conveyor Tool, Suction type (Mounting Width 1,000mm)

Miscellaneous Parts & Accessories

[A71311]

Microfiber towel

Best

FBZ

20 sheets

[A71312]

Microfiber towel

Warp Knitted

20 sheets

[A71313]

Microfiber towel

Wool

20 sheets

[70612]

Couplings PTC



[70630]

Nozzle Protector



(14 pcs)



[70930]

Gloves (coated)



[85-50005]

Shutter K26 with O-ring



[85-50185]

Shutter RL22 with O-ring



[85-50094] Omega Softener kit (Portable Water Softener)



※ The biggest risk to Optima Steamer owners is scale buildup inside the machine as a result of hard-water minerals in water. The best recommended solution for preventing is to use a salt-based water softener. While a normal-sized, household-grade water softener is suitable for the Optima Steamer, some Optima users don't have a chance to get the typical water softener, and the Omega Softener is meant to fill that void. Optima Steamer recommends using a normal-sized water softener rather than Omega Softener.

Spare Parts

[12-24003] Softener filter (spare)



Replaceable
Filter Element

[12-24002]

Chlorine filter (spare)

OPTIMA **STEAMER**

Manufacturer Information

SJE Corporation, Ltd.

78-21, Sandan 7-ro,

Jeonggwan-eup,

Gijang-gun, Busan,

South Korea

+82 51-521-3200

sales@sjecorp.com

www.sjecorp.com